

INSTALLATION INSTRUCTION for Integral Vapourlite IP65 LED battens 5 Year Warranty

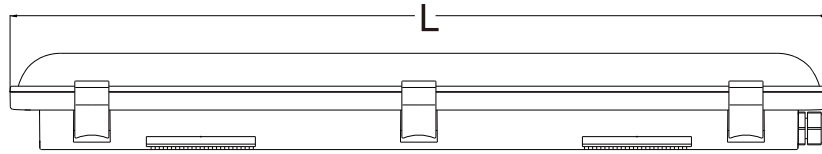
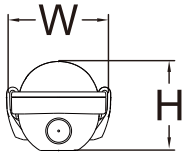

LED Batten Model	Emergency Lumens	Product Dimensions (mm) (LxWxH)	Net Weight (Kg)	
ILBTD201	2FT 10W/17W 4000K/5000K/6500K Standard	605x82x71	0.746	
ILBTD202	4FT 20W/38W 4000K/5000K/6500K Standard	1205x82x71	1.304	
ILBTD203	5FT 32W/57W 4000K/5000K/6500K Standard	1505x82x71	1.594	
ILBTD204	6FT 38W/68W 4000K/5000K/6500K Standard	1805x82x71	1.883	
ILBTD205	4FT 20W/38W 4000K/5000K/6500K Emergency	* 225	1205x82x71	1.41
ILBTD206	5FT 32W/57W 4000K/5000K/6500K Emergency	* 225	1505x82x71	1.759
ILBTD207	6FT 38W/68W 4000K/5000K/6500K Emergency	* 225	1805x82x71	2.048
ILBTD208	2FT 10W/17W 4000K/5000K/6500K Motion Sensor	605x82x71	0.791	
ILBTD209	4FT 20W/38W 4000K/5000K/6500K Motion Sensor	1205x82x71	1.339	
ILBTD210	5FT 32W/57W 4000K/5000K/6500K Motion Sensor	1505x82x71	1.629	
ILBTD211	6FT 38W/68W 4000K/5000K/6500K Motion Sensor	1805x82x71	1.928	
ILBTD212	4FT 20W/38W 4000K/5000K/6500K Emergency/Motion Sensor	* 225	1205x82x71	1.455
ILBTD213	5FT 32W/57W 4000K/5000K/6500K Emergency/Motion Sensor	* 225	1505x82x71	1.804
ILBTD214	6FT 38W/68W 4000K/5000K/6500K Emergency/Motion Sensor	* 225	1805x82x71	2.093

*Output level under emergency conditions

Thank you for purchasing an INTEGRAL LED product. When installed correctly this unit will provide years of service service – with no lamp changes required. For support or warranty information please see integral-led.com. Always turn off circuit power at the distribution unit before installation and maintenance. Please ensure that the power cannot be connected inadvertently.

Important Details – Please read prior to installation

Ensure the AC/Mains power is NOT connected and cannot be unexpectedly reconnected during installation.

General guidelines for installation:

1. This product must be installed by a competent qualified electrician in accordance with the instructions provided and in compliance with recognised electrical and safety regulations relevant to the country it is being installed.
2. This product is suitable for installation on surfaces with normal flammability e.g. wood, masonry. Before making the fixing hole(s), check that there are no obstructions hidden beneath the mounting surface, such as pipes or cables. It is not suitable for use on highly flammable surfaces or in flammable atmosphere.
3. For ceiling, wall mounted or suspended installations please follow “Installation instructions” below. For surface mount, this product must be securely fixed to the mounting surface using the brackets, screws and wall plugs supplied (Fig. 1). The screws and wall plugs are suitable for “masonry” only.
4. For the correct polarity please see “Wiring Connection”.
5. This product is not suitable for dimming.

Fixing Kit

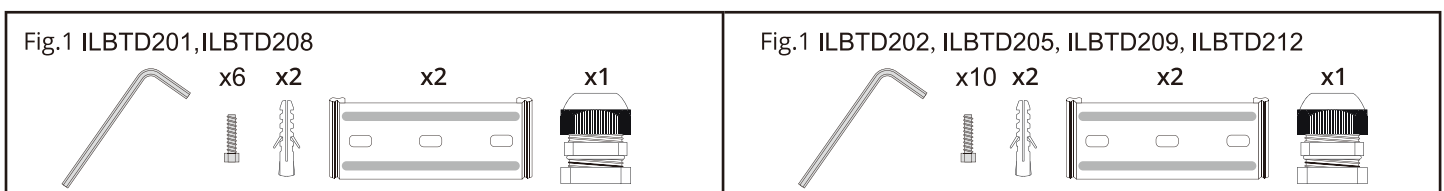

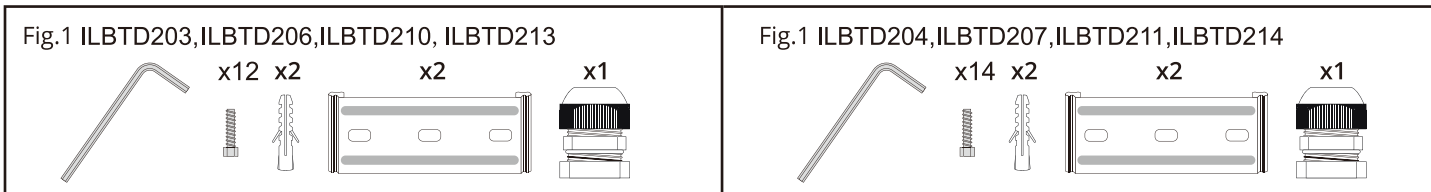

IMPORTANT! This product is a Class I device and must be connected to an earth termination.

Installation Instructions

1. Open the batten diffuser cover retaining clips. Note that there are two clips that remain attached to the housing so that the diffuser cover doesn't fall away during installation. If the clips have been secured with security bolts you will need a suitable hex key to unscrew and remove them before you can unclip the diffuser cover.
2. Release the LED and gear tray by turning the two plastic locking caps by hand to the release position. The tray may then be lifted. The connection for the mains is on the underside of the tray. Note that there are two nylon retaining straps with clips to secure the tray to the base housing. These will need to be attached for secure installation.
3. The unit is wired from the back or from the ends through breakouts carefully using a drill or by carefully knocking out. A 20mm gland is supplied for end cabling.
4. Secure the base unit to the mounting surface using the supplied fixing kit or using suspension wires which are supplied separately. Ceiling mounting height is from 3 to 6 metres for the sensor version.
5. Connect the mains supply cable to the push type terminal blocks as indicated in the "Wiring Connection" below.
6. **IMPORTANT FOR SAFETY** when reassembling the base and diffuser units.
 - a. Ensure the nylon straps are clipped to the tray
 - b. Ensure the tray is then secured to the base by turning the retaining caps with no trapped wires.
 - c. Ensure the diffuser is properly seated on the base and close the metallic retaining clips. Secure these clips with the security screws if required

Wiring Connection

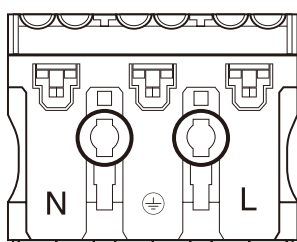

Wiring connection for all Non-Emergency units
 LIVE - (Brown) to Terminal Marked L
 NEUTRAL - (Blue) to Terminal marked N
 EARTH - (Green/Yellow) for Class 1 fittings to Terminal marked ⊕

- Connect the incoming earth cable to the earth terminal on connector block.
- Connect the incoming neutral cable to the neutral terminal marked **N** on the connector block.
- Connect the incoming live cable to terminal marked **L** on the connector block.

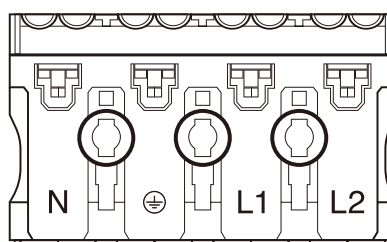

Wiring connection for emergency units

- Connect the incoming earth cable to the earth terminal on the connector block
- Connect the incoming neutral cable to the neutral terminal marked **N** on the connector block
- PERMANENT LIVE – Black to Terminal Marked L2. This will ensure that the battery charges.
Note: Any continued switching of the permanent live will reduce the battery's lifetime considerably
- SWITCH LIVE – Brown to Terminal Marked L1
- There should be a loose flying lead connected to the battery.
This needs to be attached to the empty socket found on the emergency control unit

Following power up on an emergency equipped unit, the green LED indicator should illuminate to indicate proper battery charging. If power to an emergency equipped unit is disrupted or isolated, the indicating green LED will switch off, triggering the emergency LED's to illuminate for a minimum of 3 hours. Please Allow 24 hours charge for optimum duration.

Motion Sensor operation for motion sensing units



- 1 With sufficient ambient light, the light will not be switched on.



- 2 With insufficient ambient light, the sensor switches on the light when motion is detected.



- 3 After elapse of hold time, the sensor switches off the light when no motion is detected.

The microwave sensor version provides an ON/OFF function. It has maximum installed height of 6metres and maximum detection area radius of 4metres. It is set up manually using the 8 configuration switches that are sited on the top of the LED and gear tray. Detection area, hold time and daylight threshold can be precisely set as follows: (Default setting: 100%, 5s, disabled)

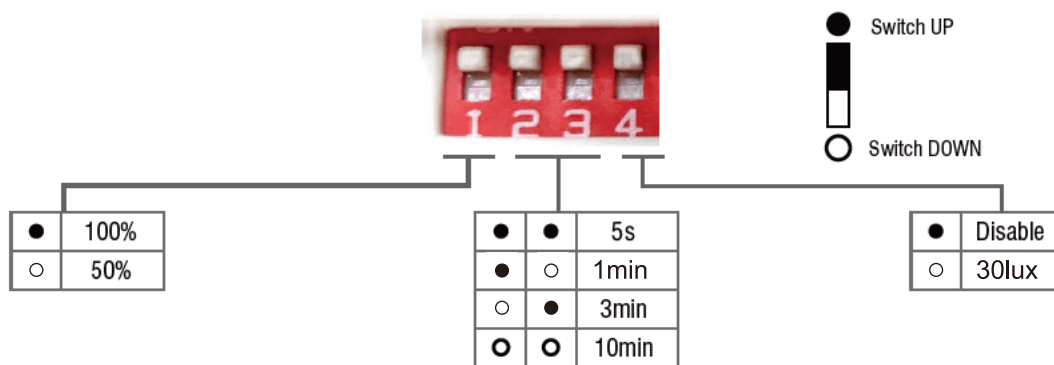

Detection area

In this area, movement will be detected and able to trigger the sensor. 100% detection area is also known as the strong sensitivity.

Hold-time

The period of light keeping 100% brightness after moving objects leave the detection area.

Daylight threshold

Definition of the ambient brightness; only when the ambient brightness is lower than the preset specific lux amount, the sensor will work; when it's preset as "disable", the sensor works everytime it detects motion regardless the ambient brightness.

DIP-switch & output current /power

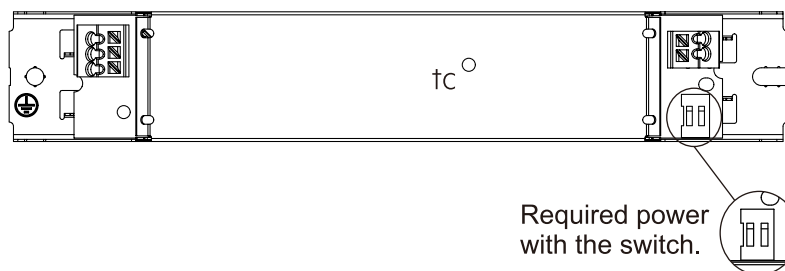

2FT

Power (W)	Output Irated(mA)	1	2
10W	200mA	--	--
12W	250mA	--	ON
14W	300mA	ON	--
17W	350mA	ON	ON

4FT

Power (W)	Output Irated(mA)	1	2
20W	200mA	--	--
26W	250mA	--	ON
32W	300mA	ON	--
38W	350mA	ON	ON

5FT

Power (W)	Output Irated(mA)	1	2
32W	200mA	--	--
40W	250mA	--	ON
48W	300mA	ON	--
57W	350mA	ON	ON

6FT

Power (W)	Output Irated(mA)	1	2
38W	200mA	--	--
48W	250mA	--	ON
58W	300mA	ON	--
68W	350mA	ON	ON

Warranty

This unit carries a 5 year warranty from the date of purchase, providing that it has been installed correctly and not modified in any way. Should a fault occur please contact the original place of purchase. Warranty for emergency batteries is 2 years.

Important Notes

- Operating and luminaire must be within rated temperature avoiding extreme humidity
- Operation must be within rated input voltage.
- Keep away from strong electromagnetic radiation sources and protect from lightning strike.
- Should the unit malfunction, return to distributor or reseller. No user serviceable parts inside. Do not disassemble or attempt to repair the luminaire outside of the installation guidelines.
- Do not install or use the luminaire if the housing/diffuser is found to be broken.
- Do not apply direct pressure to the diffuser.
- The luminaire must be installed by a qualified electrician.
- The luminaire should be positioned away from heat, vibration and liquid. Avoid contact with any corrosive chemicals.
- The Luminaire should be mounted in free air it is recommended not to exceed 30°C ambient.
- Never cover the luminaire with heat insulation materials.
- The luminaire should be positioned at least 1 metre away from radios, failure to do so may affect radio reception.
- FOR EMERGENCY MODELS - After the emergency lamp has been fully charged for a period of time, the battery inside the unit should be replaced when the rated emergency discharge time is not reached.
- For indoor or outdoor use.

Installation Diagram

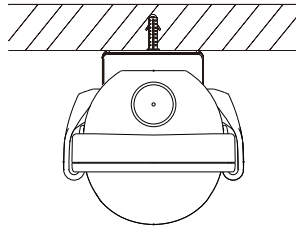
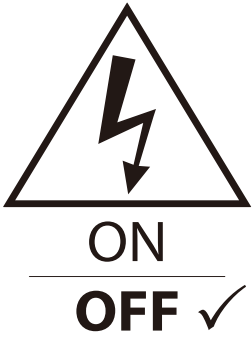

Ceiling installation

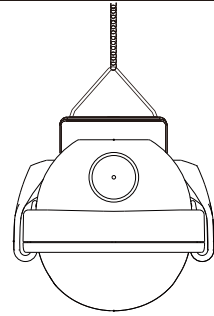

Suspended

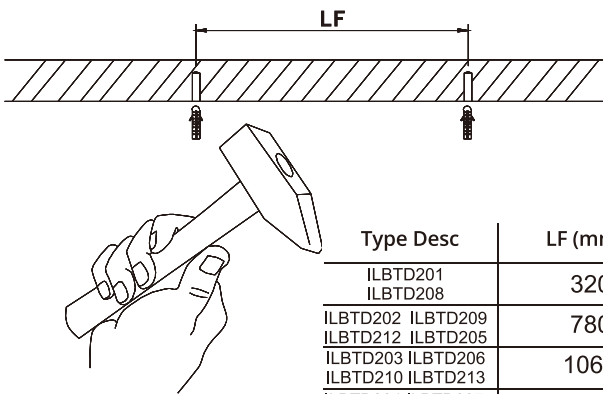

Type Desc	LF (mm)
ILBTD201 ILBTD208	320
ILBTD202 ILBTD209 ILBTD212 ILBTD205	780
ILBTD203 ILBTD206 ILBTD210 ILBTD213	1060
ILBTD204 ILBTD207 ILBTD211 ILBTD214	1360

Surface mounting

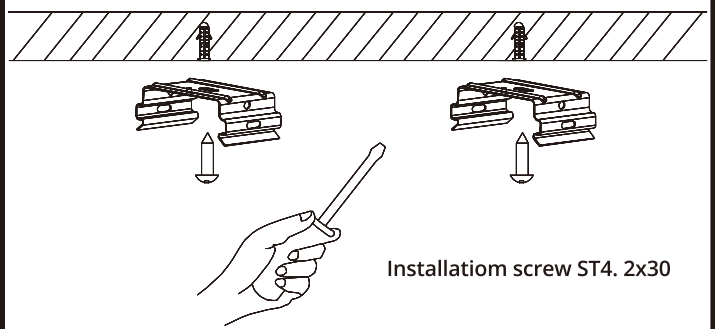

Installation screw ST4. 2x30

Suspended mounting

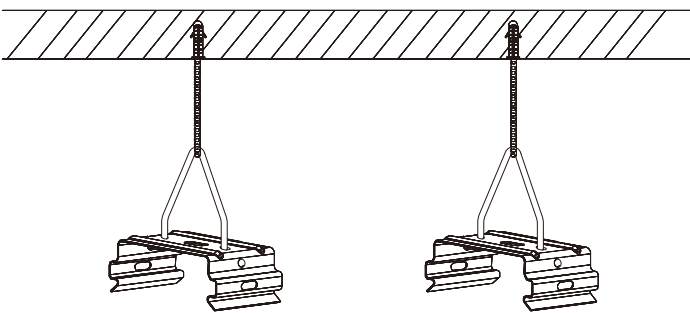

Min. 3x 1mm² H05RN-F

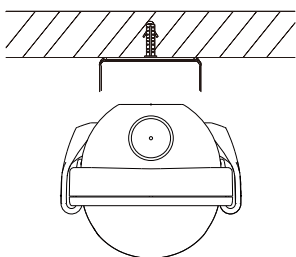
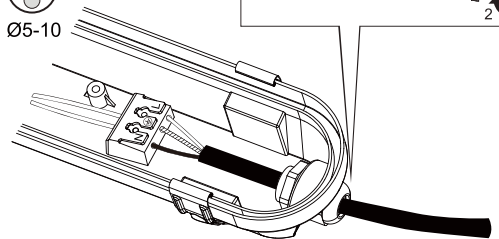
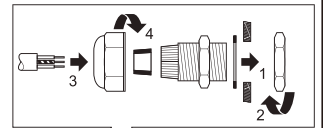
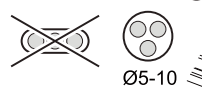
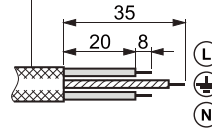

PUSH

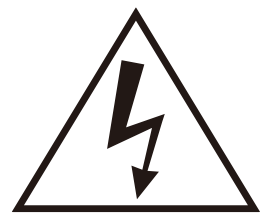
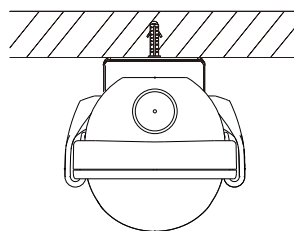

ON ✓
OFF

1. The luminaire shall be installed by a qualified electrician and wired in accordance with the latest IEE electrical regulations or the national requirements.
2. Do not switch on before complete installation.
3. The luminaire shall, under no circumstance, be covered with insulation matting or similar material.

Test Schedule to record monthly functional test and yearly 3 hour duration test for emergency version. All testing should be planned and incorporated as part of a managed programme with appropriate risk assessment to ensure operational emergency function is not compromised during testing.

Panel Ref/Location		In case of difficulty, contact the Installation Engineers: tel.				
Full Recharge Time 24 Hours			Duration 3 Hours			
TEST RECORD						
	Year 1		Year 2		Year 3	
Monthly Test	Signed	Date	Signed	Date	Signed	Date
Functional						
Functional						
Functional						
Functional						
Functional						
Functional						
Functional						
Functional						
Functional						
Functional						
Functional						
Functional						
Three Hour						



UK CA RoHS IP65



Non-Dimmable



WASTE ELECTRICAL PRODUCTS SHOULD NOT BE DISPOSED OF WITH HOUSEHOLD WASTE. PLEASE RECYCLE WHERE FACILITIES EXIST. CHECK WITH YOUR LOCAL AUTHORITY FOR RECYCLING ADVICE.

Warranty/Technical and contact information are all available at www.integral-led.com

Integral LED is a division of Integral Memory plc,
Unit 6 Iron Bridge Close, Iron Bridge Business Park,
London, NW10 0UF, UK
Integral EU BV, 2801 DG, NL